

KLT-U1MF-OV5640-1B V2.0

5MP OmniVision OV5640-1B MIPI Interface M12 Fixed Focus Camera Module



Front View



Back View

Specifications

Camera Module No.	KLT-U1MF-OV5640-1B V2.0
Resolution	5MP
Image Sensor	OV5640-1B
Sensor Type	1/4"
Pixel Size	1.4 um x 1.4 um
EFL	0.90 mm
F.NO	2.00
Pixel	2592 x 1944
View Angle	220.0°(DFOV) 187.0°(HFOV) 144.0°(VFOV)
Lens Dimensions	13.00 x 13.00 x 13.56 mm
Module Size	65.00 x 22.00 mm
Module Type	Fixed Focus
Interface	MIPI
Auto Focus VCM Driver IC	Embedded
Lens Model	KLT-LENS-TRC-F5022A6-02
Lens Type	650nm IR Cut
Operating Temperature	-30°C to +70°C
Mating Connector	AXK724147G



KLT-U1MF-OV5640-1B V2.0

5MP OmniVision OV5640-1B MIPI Interface M12 Fixed Focus Camera Module



Top View



Side View

www.KaiLapTech.com

www.KaiLapTech.com



Bottom View



Mating Connector

Version	Information	Date
V1.0	First Version	6-26-2021
V2.0	Change connector and pin out	2-16-2022

ROHS	
PIN	SIGNAL
1	NC
2	DGND
3	SDA
4	AVDD 2.8V
5	SCL
6	RESET
7	NC
8	PWDN
9	NC
10	NC
11	DOVDD 1.8V
12	MDP1
13	XCLK
14	MDN1
15	DGND
16	MCP
17	NC
18	MCN
19	NC
20	MDP0
21	NC
22	MDN0
23	AVDD 2.8V
24	DGND

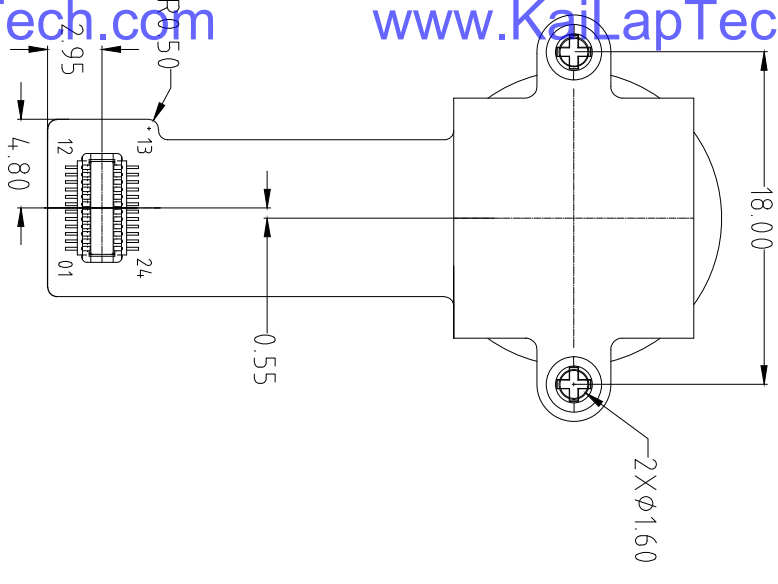
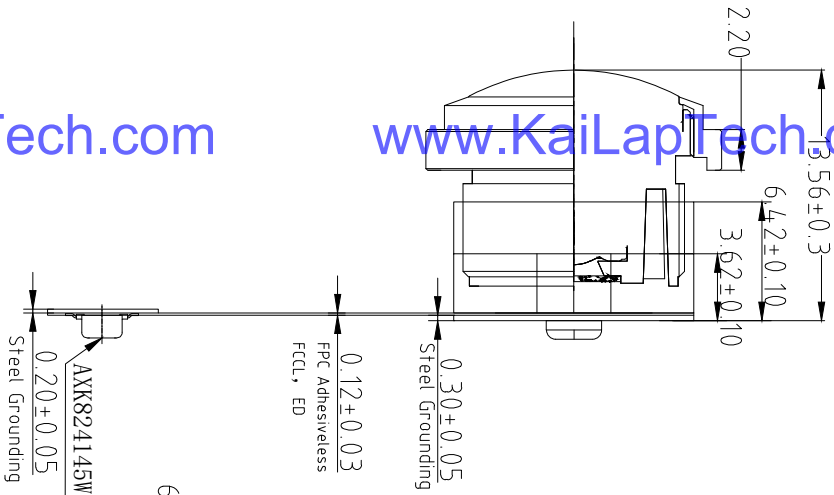
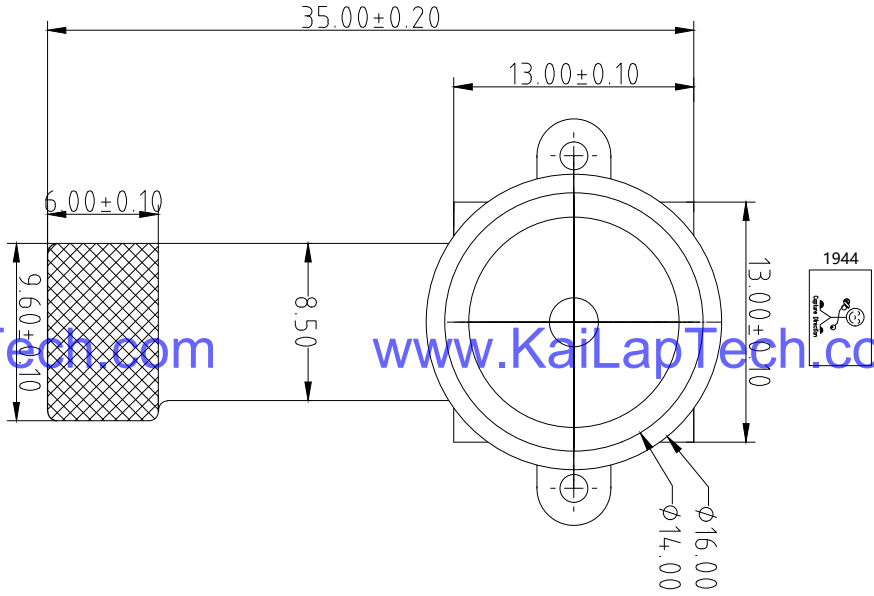

TOP VIEW

SIDE VIEW

BOTTOM VIEW

Parameters:

1、Sensor specification:

Image Sensor: OV5640-1B
 Pixel: 1.4um×1.4um
 Lens Type: 1/4
 Important Voltage Description: DVDD1.5V
 (internal power supply);

2 Lens specification:

FOV: 220°(D);187°(H);144°(V)
 F/#: 2.0
 TVDistortion: <-16%
 Focal length: 0.9mm
 Composition: 1G4P+IR FILTER
 IR Cut Coating: 650nm±10nm@50%

Kai Lap Technologies Group Ltd

Designed By

Keyin

Model Name:

KLT-U1MF-OV5640-1B V2.0

Checked By

Aouly Yan

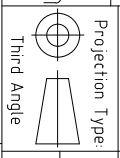

Unit: mm
 Scale: 1:1

Material: -----
 Sheet: 1 of 1

Version: 1/0

A

B

C

D

E

3

2

1

3

2

1



Lens Model: KLT-LENS-TRC-F5022A6-02

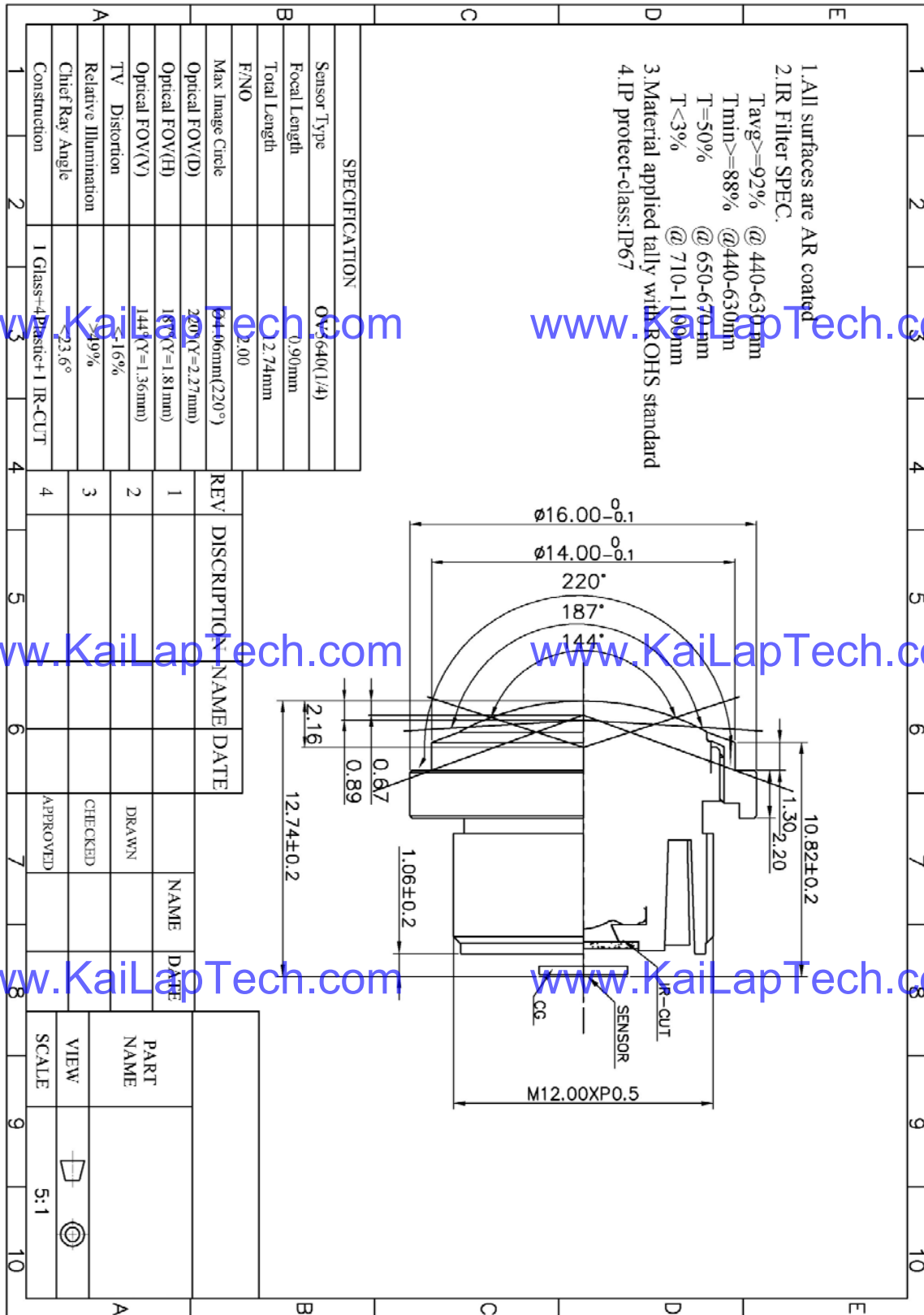

Panasonic
ideas for life

NARROW-PITCH CONNECTORS FOR BOARD-TO-BOARD AND BOARD-TO-FPC CONNECTION

NARROW PITCH (0.4mm) CONNECTORS P4 SERIES



• Without retention fitting

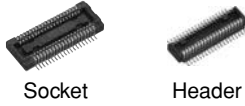

• With retention fitting

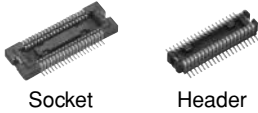

FEATURES

1. 0.4 mm pitch and support for mated heights of up to 1.5 mm, 2.0 mm, 2.5 mm, 3.0 mm, 3.5 mm, and 4.0 mm.

2. Strong resistance to adverse environments! Utilizes **TOUGH CONTACT** construction for high contact reliability.

1) Contacts are highly resistant to shock caused by dropping and employ our original bellows contact construction.

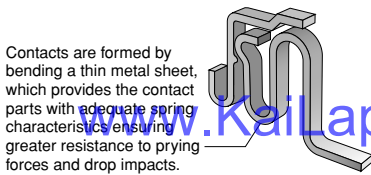

Contacts are formed by bending a thin metal sheet, which provides the contact parts with adequate spring characteristics ensuring greater resistance to prying forces and drop impacts.

2) V notch construction used for excellent resistance against foreign matters.

● What is V notch construction?

By using the edge for the contacting part and increasing contact pressure per unit area, the effectiveness in removing flux and contaminants is increased compared to its predecessor. This is also effective in preventing the trapping of contaminants.

[Cross section of contacting part]

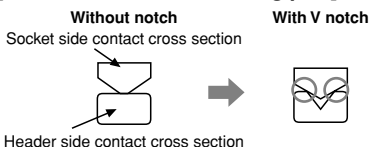

3) Use of Ni barrier construction is standard. Highly effective against solder creeping.

● What is Ni barrier construction?

By providing an exposed nickel part on the gold (Au) plated contact, solder creeping is prevented despite the ultra low profile.

[Contact]

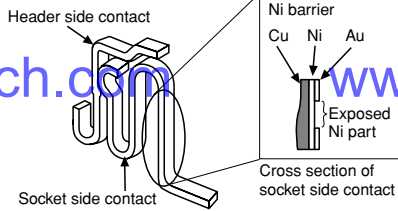

Note: Construction makes solder creeping difficult because header side is formed at the same time.

4) Porosity treatment applied for improved resistance against corrosion.

What is porosity treatment?

This treatment consists of coating the surface with a very thin film to seal pinholes in the gold plating. This porosity treatment technology ensures the same contact reliability for thin gold plating as that of thick gold plating.

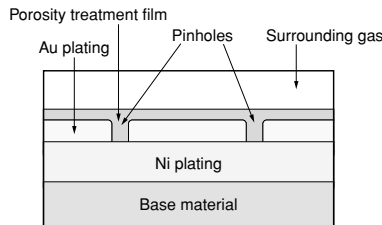

- Improvement in insertion/removal durability
- Improvement in resistance to corrosion
- Improvement in contact reliability for digital signals

3. It is constructed with impact dispersion keys inside the body to disperse shocks when dropped.

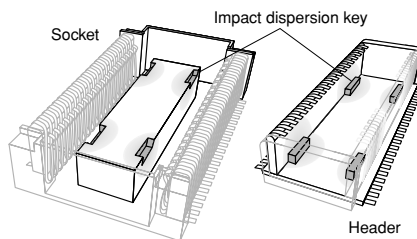

A high level of shock resistance is ensured by dispersing impact over the four locations where the socket indentations and header protrusions are mated together.

Note: The following numbers of contacts are not supported due to suction surface factors.

- Without retention fitting: 18 contacts or less
 - With retention fitting: 22 contacts or less
4. Construction makes designing devices easier.

1) The lower connector bottom surface construction prevents contact and shorts between the PCB and metal terminals. This enables freedom in pattern wiring, helping to make PCB's smaller.

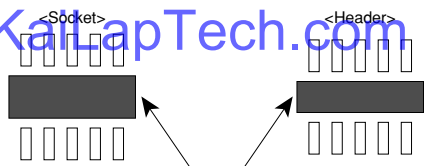

Connector bottom: Create any thru-hole and pattern wiring.

2) Guides are provided to take up any position shift and facilitate insertion.

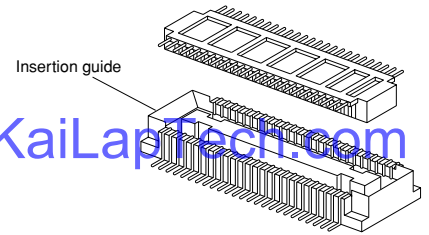

3) The connector has a simple lock mechanism. Superior mated operation with click feel to indicate that mated is complete.

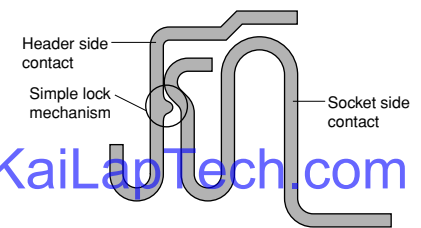

5. Design makes efficient mounting. Features a terminal flatness of 0.08 mm, construction resistant to creeping flux, and design that facilitates visual inspection of the soldered part.

6. Compliance with RoHS Directive Environmentally friendly, the connectors comply with Europe's RoHS Directive. Cadmium, lead, mercury, hexavalent chromium, PBB and PBDE are not used.

7. Connectors for inspection available Connectors for inspection are available that are ideal for modular unit inspection and inspection in device assembly processes.

APPLICATIONS

Compact portable devices “Cellular phones, DVC, Digital cameras, etc”

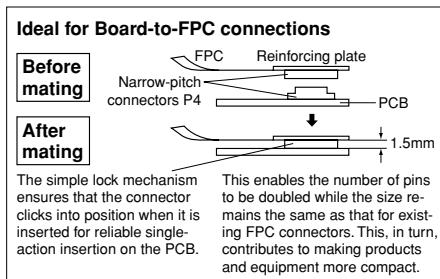

TABLE OF PRODUCT TYPES

P4 (0.4 mm pitch): Without retention fitting



P4 (0.4 mm pitch): With retention fitting



☆: Available for sale

Number of contacts	Mated height						
	1.5mm	2.0mm	2.5mm	3.0mm	3.5mm	4.0mm	
14	☆	☆	☆				
16	☆						
20	☆	☆	☆				
22	☆						
24	☆	☆	☆				
26	☆	☆					
28	☆						
30	☆	☆	☆				
34	☆	☆					
36	☆						
40	☆	☆	☆				
44	☆		☆				
50	☆	☆	☆				
54	☆						
60	☆		☆				
64	☆						
70	☆	☆	☆				
80	☆	☆					
90	☆		☆				
100	☆	☆	☆				

☆: Available for sale

Number of contacts	Mated height						
	1.5mm	2.0mm	2.5mm	3.0mm	3.5mm	4.0mm	
10	☆						
12	☆						
20			☆	☆	☆		
22	☆						
24		☆					
28	☆						
30	☆						
32			☆				
34	☆		☆			☆	
40	☆		☆	☆			
44	☆						
46	☆						
50	☆		☆	☆	☆	☆	
60	☆		☆	☆	☆		
80	☆	☆	☆	☆	☆	☆	
90	☆		☆	☆	☆		
100	☆						

Note: Please contact us regarding numbers of contacts other than those given above.

www.KaiLapTech.com

www.KaiLapTech.com

AXK7, 8

ORDERING INFORMATION

AXK

7: Narrow Pitch Connector P4 (0.4 mm pitch) Socket
8: Narrow Pitch Connector P4 (0.4 mm pitch) Header

Number of contacts (2 digits)

Mated height

<Socket>

- 1: For mated height 1.5 mm
- 2: For mated height 2.0 mm
- 3: For mated height 2.5 mm and 3.0 mm
- 4: For mated height 3.5 mm
- 5: For mated height 4.0 mm

<Header>

- 1: For mated height 1.5 mm, 2.0 mm and 2.5 mm
- 2: For mated height 3.0 mm, 3.5 mm and 4.0 mm

Functions

- 1: With retention fitting, with positioning bosses
- 2: With retention fitting, without positioning bosses
- 3: Without retention fitting, with positioning bosses
- 4: Without retention fitting, without positioning bosses

Surface treatment (Contact portion / Terminal portion)

<Socket>

- 5: Ni plating on base, Au plating on surface
- 7: Ni plating on base, Au plating on surface (for Ni barrier product available)

<Header>

- 5: Ni plating on base, Au plating on surface

Other specifications

<Header>

- Y: V notch type product
- W: V notch and post edge horseshoe bend type product Note*

Packing

G: 3,000 pieces embossed tape and plastic reel × 2*

* Only a socket of mated height 3.5 mm and 4.0 mm: 2,000 pieces embossed tape and plastic reel × 2.

Note:

The post edge horseshoe bend indicated by the "W" in the tenth digit of the header part number refers to a construction that makes it difficult for the header post edge to deform when the connector is inserted and removed at an angle.

www.KaiLapTech.com

www.KaiLapTech.com

PRODUCT TYPES

1. Without retention fitting 

Mated height	Number of contacts	Part number			Packing	
		Socket	Header		Inner carton	Outer carton
		<i>TOUGH CONTACT</i>	<i>TOUGH CONTACT</i>	<i>TOUGH CONTACT</i> and Post edge horseshoe bend type (Recommendation)		
1.5 mm	14	AXK714147G	AXK814145YG	AXK814145WG	3,000 pieces	6,000 pieces
	16	AXK716147G	AXK816145YG	AXK816145WG		
	20	AXK720147G	AXK820145YG	AXK820145WG		
	22	AXK722147G	AXK822145YG	AXK822145WG		
	24	AXK724147G	AXK824145YG	AXK824145WG		
	26	AXK726147G	AXK826145YG	AXK826145WG		
	28	AXK728147G	AXK828145YG	AXK828145WG		
	30	AXK730147G	AXK830145YG	AXK830145WG		
	34	AXK734147G	AXK834145YG	AXK834145WG		
	36	AXK736147G	AXK836145YG	AXK836145WG		
	40	AXK740147G	AXK840145YG	AXK840145WG		
	44	AXK744147G	AXK844145YG	AXK844145WG		
	50	AXK750147G	AXK850145YG	AXK850145WG		
	54	AXK754147G	AXK854145YG	AXK854145WG		
	60	AXK760147G	AXK860145YG	AXK860145WG		
	64	AXK764147G	AXK864145YG	AXK864145WG		
	70	AXK770147G	AXK870145YG	AXK870145WG		
80	AXK780147G	AXK880145YG	AXK880145WG			
90	AXK790147G	AXK890145YG	AXK890145WG			
100	AXK700147G	AXK800145YG	AXK800145WG			
2.0 mm	14	AXK714247G	AXK814145YG	AXK814145WG	3,000 pieces	6,000 pieces
	20	AXK720247G	AXK820145YG	AXK820145WG		
	24	AXK724247G	AXK824145YG	AXK824145WG		
	26	AXK726247G	AXK826145YG	AXK826145WG		
	30	AXK730247G	AXK830145YG	AXK830145WG		
	34	AXK734247G	AXK834145YG	AXK834145WG		
	40	AXK740247G	AXK840145YG	AXK840145WG		
	50	AXK750247G	AXK850145YG	AXK850145WG		
	70	AXK770247G	AXK870145YG	AXK870145WG		
	100	AXK700247G	AXK800145YG	AXK800145WG		
2.5 mm	14	AXK714347G	AXK814145YG	AXK814145WG	3,000 pieces	6,000 pieces
	20	AXK720347G	AXK820145YG	AXK820145WG		
	24	AXK724347G	AXK824145YG	AXK824145WG		
	30	AXK730347G	AXK830145YG	AXK830145WG		
	40	AXK740347G	AXK840145YG	AXK840145WG		
	44	AXK744347G	AXK844145YG	AXK844145WG		
	50	AXK750347G	AXK850145YG	AXK850145WG		
	60	AXK760347G	AXK860145YG	AXK860145WG		
	70	AXK770347G	AXK870145YG	AXK870145WG		
	100	AXK700347G	AXK800145YG	AXK800145WG		

- Notes: 1. Regarding ordering units; During production: Please make orders in 1-reel units.
 Samples for mounting confirmation: Available in units of 50 pieces. Please consult us. (See "Regarding sample orders to confirm proper mounting" on page 13.)
 Samples: Small lot orders are possible.
2. The standard type comes without positioning bosses. Connectors with positioning bosses are available on-demand production. For this type of connector, 8th digit of the part number changes from 4 to 3. e.g. Mated height 1.5 mm and 20 contacts for socket without retention fitting: AXK720137G
3. The 10th digit "Y" in the header part number indicates the connector has V notch. (For details, please refer to page 36.)
 "W" indicates a product with V notch and post edge horseshoe bend. ("Post edge horseshoe bend" refers to a construction that makes it difficult for the header post edge to deform when the connector is inserted and removed at an angle.)
 "Products with V notch" and "products with V notch and post edge horseshoe bend" are mating compatible.
4. Connectors of different mated height (3.0 mm, 3.5 mm and 4.0 mm) and different number of contacts are available on-demand production only. Please contact us for more details.

SPECIFICATIONS

1. Characteristics

	Item	Specifications	Conditions
Electrical characteristics	Rated current	0.3A/contact (Max. 5 A at total contacts)	
	Rated voltage	60V AC/DC	
	Breakdown voltage	150V AC for 1 min.	Detection current: 1mA
	Insulation resistance	Min. 1,000M Ω (initial)	Using 250V DC megger (applied for 1 min.)
	Contact resistance	Max. 70m Ω	Measured based on the HP4338B measurement method of JIS C 5402
Mechanical characteristics	Composite insertion force	Max. 0.981N {100gf}/contacts \times contacts (initial)	
	Composite removal force	Min. 0.0588N {6gf}/contacts \times contacts (Mated height 1.5 mm, without removal and retention fitting) Min. 0.118N {12gf}/contacts \times contacts (Mated height 1.5 mm, except without removal and retention fitting)	
	Post holding force	Min. 0.981N {100gf}/contacts	Measures the maximum load in the post axial direction until removal
Environmental characteristics	Ambient temperature	-55°C to +85°C	No freezing at low temperatures
	Soldering heat resistance	Max. peak temperature of 245°C 300°C within 5 sec. 350°C within 3 sec.	Infrared reflow soldering Soldering iron
	Thermal shock resistance (header and socket mated)	5 cycles, insulation resistance min. 100M Ω , contact resistance max. 70m Ω	Sequence 1. -55 \pm 3°C, 30 minutes 2. ~, Max. 5 minutes 3. 85 \pm 3°C, 30 minutes 4. ~, Max. 5 minutes
	Humidity resistance (header and socket mated)	120 hours, insulation resistance min. 100M Ω , contact resistance max. 70m Ω	Bath temperature 40 \pm 2°C, humidity 90 to 95% R.H.
	Saltwater spray resistance (header and socket mated)	24 hours, insulation resistance min. 100M Ω , contact resistance max. 70m Ω	Bath temperature 35 \pm 2°C, saltwater concentration 5 \pm 1%
	H ₂ S resistance (header and socket mated)	48 hours, contact resistance max. 70m Ω	Bath temperature 40 \pm 2°C, gas concentration 3 \pm 1 ppm, humidity 75 to 80% R.H.
Lifetime characteristics	Insertion and removal life	50 times	Repeated insertion and removal speed of max. 200 times/hours
Unit weight		Mated height 1.5mm, 20 contacts; Socket: 0.04g Header: 0.02g	

2. Material and surface treatment

Part name	Material	Surface treatment
Molded portion	Heat-resistant resin (UL94V-0), Black	—
Contact and Post	Copper alloy	Contact portion: Ni plating on base, Au plating on surface Terminal portion: Ni plating on base, Au plating on surface (Except for thick of terminal) However, upper terminal of Ni barrier production: Exposed over Ni The area adjacent to the terminal of the sockets on models with Ni barrier is exposed to Ni on base.
Retention fitting portion	Copper alloy	Ni plating on base, Sn plating on surface (Except for front terminal)

AXK7, 8

DIMENSIONS (mm)

1. Without Retention Fitting

Socket (Mated height: 1.5 mm, 2.0 mm, and 2.5 mm)

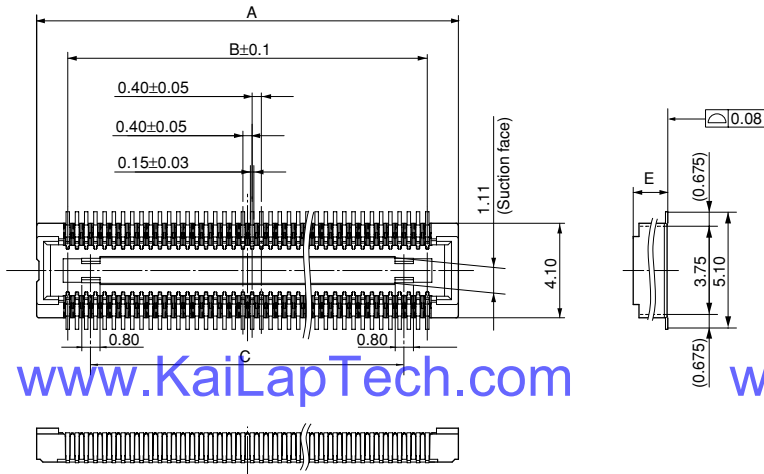

www.KaiLapTech.com

www.KaiLapTech.com

Max. 18 contacts

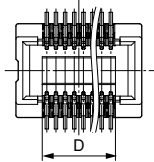

General tolerance: ±0.2

Dimension table (mm)

Number of contacts/ dimension	A	B	C	D
14	5.1	2.4	—	2.8
16	5.5	2.8	—	3.2
20	6.3	3.6	1.6	—
22	6.7	4.0	2.0	—
24	7.1	4.4	2.4	—
26	7.5	4.8	2.8	—
28	7.9	5.2	3.2	—
30	8.3	5.6	3.6	—
34	9.1	6.4	4.4	—
36	9.5	6.8	4.8	—
40	10.3	7.6	5.6	—
44	11.1	8.4	6.4	—
50	12.3	9.6	7.6	—
54	13.1	10.4	8.4	—
60	14.3	11.6	9.6	—
64	15.1	12.4	10.4	—
70	16.3	13.6	11.6	—
80	18.3	15.6	13.6	—
90	20.3	17.6	15.6	—
100	22.3	19.6	17.6	—

Mated height/dimension	E
1.5mm	1.50
2.0mm	1.92
2.5mm	2.42

www.KaiLapTech.com

www.KaiLapTech.com

Header (Mated height: 1.5 mm, 2.0 mm, and 2.5 mm "products with V notch")

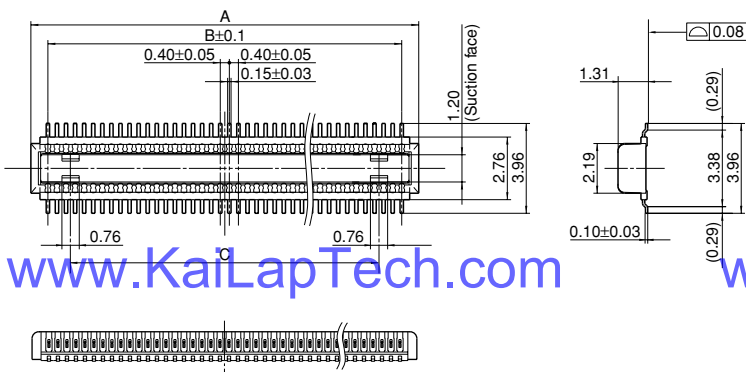

www.KaiLapTech.com

www.KaiLapTech.com

Max. 18 contacts

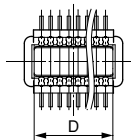

General tolerance: ±0.2

Dimension table (mm)

Number of contacts/ dimension	A	B	C	D
14	3.9	2.4	—	3.04
16	4.3	2.8	—	3.44
20	5.1	3.6	1.6	—
22	5.5	4.0	2.0	—
24	5.9	4.4	2.4	—
26	6.3	4.8	2.8	—
28	6.7	5.2	3.2	—
30	7.1	5.6	3.6	—
34	7.9	6.4	4.4	—
36	8.3	6.8	4.8	—
40	9.1	7.6	5.6	—
44	9.9	8.4	6.4	—
50	11.1	9.6	7.6	—
54	11.9	10.4	8.4	—
60	13.1	11.6	9.6	—
64	13.9	12.4	10.4	—
70	15.1	13.6	11.6	—
80	17.1	15.6	13.6	—
90	19.1	17.6	15.6	—
100	21.1	19.6	17.6	—

Note: "Products with V notch" and "products with V notch and post edge horseshoe bend" are mating compatible.

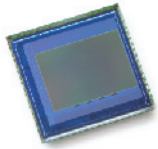

OV5640 5-megapixel product brief



1/4-inch, 5-Megapixel SOC Image Sensor Optimized for High-Volume Mobile Markets



available in
a lead free
package

The OV5640 delivers a complete 5-megapixel camera solution on a single chip, aimed at offering cost efficiencies that serve the high-volume autofocus (AF) camera phone market. The system-on-a-chip (SOC) sensor features OmniVision's 1.4 micron OmniBSI™ backside illumination architecture to deliver excellent pixel performance and best-in-class low-light sensitivity, while enabling ultra compact camera module designs of 8.5 mm x 8.5 mm with <6 mm z-height. The OV5640 provides the full functionality of a complete camera, including anti-shake technology, AF control, and MIPI while being easier to tune than two-chip solutions, making it an ideal choice in terms of cost, time-to-market and ease of platform integration.

The OV5640 enables 720p HD video at 60 frames per second (fps) and 1080p HD video at 30 fps with complete user control over formatting and output data transfer. The 720p/60 HD video is captured in full field of view (FOV) with 2 x 2 binning, which doubles the sensitivity and improves the signal-to-noise ratio (SNR). Additionally, a unique post-binning re-sampling filter function removes zigzag artifacts around slant edges and minimizes spatial artifacts to deliver even sharper, crisper

color images. To further improve camera performance and user experience, the OV5640 features an internal anti-shake engine for image stabilization, and it supports Scalado™ tagging for faster image preview and zoom.

The OV5640 offers a digital video port (DVP) parallel interface and a high-speed dual lane MIPI interface, supporting multiple output formats. An integrated JPEG compression engine simplifies data transfer for bandwidth-limited interfaces. The sensor's automatic image control functions include automatic exposure control (AEC), automatic white balance (AWB), automatic band filter (ABF), 50/60 Hz automatic luminance detection, and automatic black level calibration (ABLC). The OV5640 delivers programmable controls for frame rate, AEC/AGC 16-zone size/position/weight control, mirror and flip, cropping, windowing, and panning. It also offers color saturation, hue, gamma, sharpness (edge enhancement), lens correction, defective pixel canceling, and noise canceling to improve image quality.

Find out more at www.ovt.com.

applications

- cellular phones
- toys
- PC multimedia
- digital still cameras

ordering information

- OV05640-A71A-1B** (color, lead-free)
71-pin CSP

features

- 1.4 μm x 1.4 μm pixel with OmniBSI technology for high performance (high sensitivity, low crosstalk, low noise, improved quantum efficiency)
- optical size of 1/4"
- automatic image control functions: automatic exposure control (AEC), automatic white balance (AWB), automatic band filter (ABF), automatic 50/60 Hz luminance detection, and automatic black level calibration (ABLC)
- programmable controls for frame rate, AEC/AGC 16-zone size/position/weight control, mirror and flip, cropping, windowing, and panning
- image quality controls: color saturation, hue, gamma, sharpness (edge enhancement), lens correction, defective pixel cancelling, and noise cancelling
- support for output formats: RAW RGB, RGB565/555/444, CCIR656, YUV422/420, YCbCr422, and compression
- support for video or snapshot operations
- support for internal and external frame synchronization for frame exposure mode
- support for LED and flash strobe mode
- support for horizontal and vertical sub-sampling, binning
- support for minimizing artifacts on binned image
- support for data compression output
- support for anti-shake
- standard serial SCCB interface
- digital video port (DVP) parallel output interface and dual lane MIPI output interface
- embedded 1.5V regulator for core power
- programmable I/O drive capability, I/O tri-state configurability
- support for black sun cancellation
- support for images sizes: 5 megapixel, and any arbitrary size scaling down from 5 megapixel
- support for auto focus control (AFC) with embedded AF VCM driver
- embedded microcontroller
- suitable for module size of 8.5 x 8.5 x <6mm with both CSP and RW packaging

key specifications (typical)

- active array size:** 2592 x 1944
- power supply:**
 - core: 1.25 ~ 1.675V (with embedded 1.5V regulator)
 - analog: 2.6 ~ 3.0V (2.8V typical)
 - I/O: 1.8V / 2.8V
- power requirements:**
 - active: 140 mA
 - standby: 20 μA
- temperature range:**
 - operating: -30°C to 70°C junction temperature (see [table 8-2](#))
 - stable image: 0°C to 50°C junction temperature (see [table 8-2](#))
- output formats:** 8-/10-bit RGB RAW output
- lens size:** 1/4"
- lens chief ray angle:** 24° (see [figure 10-2](#))
- input clock frequency:** 6~27 MHz
- max S/N ratio:** 36 dB
- dynamic range:** 68 dB @ 8x gain
- maximum image transfer rate:**
 - QSXGA (2592x1944): 15 fps
 - 1080p: 30 fps
 - 1280x960: 45 fps
 - 720p: 60 fps
 - VGA (640x480): 90 fps
- sensitivity:** 600 mV/Lux-sec
- shutter:** rolling shutter / frame exposure
- maximum exposure interval:** 1964 x t_{ROW}
- pixel size:** 1.4 μm x 1.4 μm
- dark current:** 8 mV/s @ 60°C junction temperature
- image area:** 3673.6 μm x 2738.4 μm
- package dimensions:** 5985 μm x 5835 μm



Camera Module Pinout Definition Reference Chart

OmniVision	Sony	Samsung	On-Semi	Aptina	Himax	GalaxyCore	PixArt	SmartSens	Sensors
Pin Signal		Description							
DGND GND		ground for digital circuit							
AGND		ground for analog circuit							
PCLK DCK		DVP PCLK output							
XCLR PWDN XSHUTDOWN STANDBY		power down active high with internal pull-down resistor							
MCLK XVCLK XCLK INCK		system input clock							
RESET RST		reset active low with internal pull-up resistor							
NC NULL		no connect							
SDA SIO_D SIOD		SCCB data							
SCL SIO_C SIOC		SCCB input clock							
VSYNC XVS FSYNC		DVP VSYNC output							
HREF XHS		DVP HREF output							
DOVDD		power for I/O circuit							
AFVDD		power for VCM circuit							
AVDD		power for analog circuit							
DVDD		power for digital circuit							
STROBE FSTROBE		strobe output							
FSIN		synchronize the VSYNC signal from the other sensor							
SID		SCCB last bit ID input							
ILPWM		mechanical shutter output indicator							
FREQ		frame exposure / mechanical shutter							
GPIO		general purpose inputs							
SLASEL		I2C slave address select							
AFEN		CEN chip enable active high on VCM driver IC							
MIPI Interface									
MDN0 DN0 MD0N DATA_N DMO1N		MIPI 1st data lane negative output							
MDP0 DP0 MD0P DATA_P DMO1P		MIPI 1st data lane positive output							
MDN1 DN1 MD1N DATA2_N DMO2N		MIPI 2nd data lane negative output							
MDP1 DP1 MD1P DATA2_P DMO2P		MIPI 2nd data lane positive output							
MDN2 DN2 MD2N DATA3_N DMO3N		MIPI 3rd data lane negative output							
MDP2 DP2 MD2P DATA3_P DMO3P		MIPI 3rd data lane positive output							
MDN3 DN3 MD3N DATA4_N DMO4N		MIPI 4th data lane negative output							
MDP3 DP3 MD3P DATA4_P DMO4P		MIPI 4th data lane positive output							
MCN CLKN CLK_N DCKN		MIPI clock negative output							
MCP CLKP MCP CLK_P DCKN		MIPI clock positive output							
DVP Parallel Interface									
D0 DO0 Y0		DVP data output port 0							
D1 DO1 Y1		DVP data output port 1							
D2 DO2 Y2		DVP data output port 2							
D3 DO3 Y3		DVP data output port 3							
D4 DO4 Y4		DVP data output port 4							
D5 DO5 Y5		DVP data output port 5							
D6 DO6 Y6		DVP data output port 6							
D7 DO7 Y7		DVP data output port 7							
D8 DO8 Y8		DVP data output port 8							
D9 DO9 Y9		DVP data output port 9							
D10 DO10 Y10		DVP data output port 10							
D11 DO11 Y11		DVP data output port 11							



your BEST camera module partner

Cameras Applications



www.KaiLapTech.com



www.KaiLapTech.com



www.KaiLapTech.com

www.KaiLapTech.com



www.KaiLapTech.com



www.KaiLapTech.com



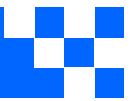

Camera Reliability Test

Reliability Inspection Item		Testing Method	Acceptance Criteria	
Category	Item			
Environmental	Storage Temperature	High 60°C 96 Hours	Temperature Chamber	No Abnormal Situation
		Low -20°C 96 Hours	Temperature Chamber	No Abnormal Situation
	Operation Temperature	High 60°C 24 Hours	Temperature Chamber	No Abnormal Situation
		Low -20°C 24 Hours	Temperature Chamber	No Abnormal Situation
	Humidity	60°C 80% 24 Hours	Temperature Chamber	No Abnormal Situation
	Thermal Shock	High 60°C 0.5 Hours Low -20°C 0.5 Hours Cycling in 24 Hours	Temperature Chamber	No Abnormal Situation
Physical	Drop Test (Free Falling)	Without Package 60cm	10 Times on Wood Floor	Electrically Functional
		With Package 60cm	10 Times on Wood Floor	Electrically Functional
	Vibration Test	50Hz X-Axis 2mm 30min	Vibration Table	Electrically Functional
		50Hz Y-Axis 2mm 30min	Vibration Table	Electrically Functional
		50Hz Z-Axis 2mm 30min	Vibration Table	Electrically Functional
Cable Tensile Strength Test	Loading Weight 4 kg 60 Seconds Cycling in 24 Hours	Tensile Testing Machine	Electrically Functional	
Electrical	ESD Test	Contact Discharge 2 KV	ESD Testing Machine	Electrically Functional
		Air Discharge 4 KV	ESD Testing Machine	Electrically Functional
	Aging Test	On/Off 30 Seconds Cycling in 24 Hours	Power Switch	Electrically Functional
	USB Connector	On/Off 250 Times	Plug and Unplug	Electrically Functional





Inspection Item		Inspection Method	Standard of Inspection	
Category	Item			
Appearance	FPC/ PCB	Color	The Naked Eye	Major Difference is Not Allowed.
		Be Torn/Chopped	The Naked Eye	Copper Crack Exposure is Not Allowed.
		Marking	The Naked Eye	Clear, Recognizable (Within 30cm Distance)
	Holder	Scratches	The Naked Eye	The Inside Crack Exposure is Not Allowed
		Gap	The Naked Eye	Meet the Height Standard
		Screw	The Naked Eye	Make Sure Screws Are Presented (If Any)
		Damage	The Naked Eye	The Inside Crack Exposure is Not Allowed
	Lens	Scratch	The Naked Eye	No Effect On Resolution Standard
		Contamination	The Naked Eye	No Effect On Resolution Standard
		Oil Film	The Naked Eye	No Effect On Resolution Standard
		Cover Tape	The Naked Eye	No Issue On Appearance.
	Function	Image	No Communication	Test Board
Bright Pixel			Black Board	Not Allowed In the Image Center
Dark Pixel			White board	Not Allowed In the Image Center
Blurry			The Naked Eye	Not Allowed
No Image			The Naked Eye	Not Allowed
Vertical Line			The Naked Eye	Not Allowed
Horizontal Line			The Naked Eye	Not Allowed
Light Leakage			The Naked Eye	Not Allowed
Blinking Image			The Naked Eye	Not Allowed
Bruise			Inspection Jig	Not Allowed
Resolution			Chart	Follows Outgoing Inspection Chart Standard
Color			The Naked Eye	No Issue
Noise			The Naked Eye	Not Allowed
Corner Dark			The Naked Eye	Less Than 100px By 100px
Color Resolution			The Naked Eye	No Issue
Dimension	Height	The Naked Eye	Follows Approval Data Sheet	
	Width	The Naked Eye	Follows Approval Data Sheet	
	Length	The Naked Eye	Follows Approval Data Sheet	
	Overall	The Naked Eye	Follows Approval Data Sheet	



KLT Package Solutions

KLT Camera Module



Complete with Lens Protection Film



Tray with Grid and Space



Place Cameras on the Tray





Camera Modules Package Solution

Full Tray of Cameras



Cover Tray with Lid



Put Tray into Anti-Static Bag



Vacuum the Anti-Static Bag

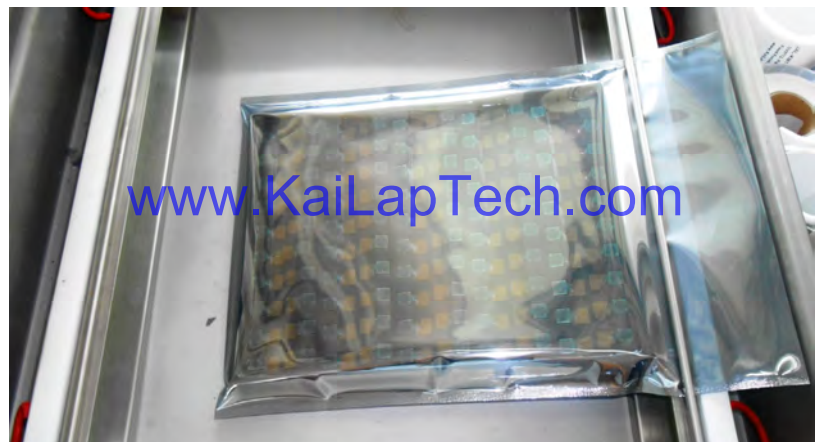



Camera Modules Package Solution

Sealed Vacuum Bag with Labels

- 1. Model and Description 2. Quantity 3. Shipping Date 4. Caution**





CMOS CAMERA MODULES



your BEST camera module partner

Large Order Package Solution

Place Foam Sheets Between Trays

Foam Sheets are Slightly Larger than Trays



www.KaiLapTech.com

www.KaiLapTech.com

Place Foam Sheets and Trays into Box

Foam Sheets are Tightly Fitting Box



www.KaiLapTech.com sales@KaiLapTech.com Tel: (852) 6908 1256 Fax: (852) 3017 6778

All rights reserved @ Kai Lap Technologies Group Ltd. Specifications subject to change without notice.



CMOS CAMERA MODULES



your BEST camera module partner

Small Order Package Solution

Place Foam Sheets and Trays into Small Box



www.KaiLapTech.com

Package in Small Box for Shipment

Foam Sheets are Nicely Fitting the Small Box



www.KaiLapTech.com

Place Small Boxes into Larger Box



www.KaiLapTech.com sales@KaiLapTech.com Tel: (852) 6908 1256 Fax: (852) 3017 6778

All rights reserved @ Kai Lap Technologies Group Ltd. Specifications subject to change without notice.



Carbon Box Package Solution

Seal the Carbon Box

Final Package Labelled Box



Carbon Box Ready for Shipment

1. Delivery Address and Phone No.
2. Box No. and Ship Date
3. Fragile Caution





Sample Order Package Solution

Place Sample into Small Anti-Static Bag



Place Connectors into Small Ant-Static Bag



Sample Labels on the Small Bag

1. Camera Module or Connector Model
2. Shipping Date and Quantity
3. Caution





Connectors Large Order Package Solution

Connectors in a Wheel



Label Connectors in the Wheel



The Wheel is Perfectly Fitting the Box



Connectors Box Ready for Shipment



Company Kai Lap Technologies (KLT)

Kai Lap Technologies Group Limited. (KLT) was established in 2009, a next-generation technology driven manufacturer specialized in research, design, and produce of audio and video products. KLT is occupying 20,000 square feet automated plants with 100 employees of annual throughput 30,000,000 units cameras.

KLT provides OEM, ODM design, contract manufacturing, and builds the camera products. You may provide the requirements to us, even with a hand draft, our sales and engineering work together to meet your needs. We consider ourselves your last-term partner in developing practical and innovative solutions.

Our team covers everything from initial concept development to mass produced product. KLT specializes in customized camera design, raw material, electronic engineering, firmware/software development, product testing, and packing design. Our experienced strategic supply systems offer a robust and dependable manufacturing capacity for orders of various sizes.

www.KaiLapTech.com

www.KaiLapTech.com



Limited Warranty

KLT provides the following limited warranty if you purchased the Product(s) directly from KLT company or from KLT's website, www.KaiLapTech.com. Product(s) purchased from other sellers or sources are not covered by this Limited Warranty. KLT guarantees that the Product(s) will be free from defects in materials and workmanship under normal use for a period of one (1) year from the date you receive the product ("Warranty Period").

For all Product(s) that contain or develop material defects in materials or workmanship during the Warranty Period, KLT will, at its sole option, either: (i) repair the Product(s); (ii) replace the Product(s) with a new or refurbished Product(s) (replacement Product(s) being of identical model or functional equivalent); or (iii) provide you a refund of the price you paid for the Product(s).

This Limited Warranty of KLT is solely limited to repair and/or replacement on the terms set forth above. KLT is not reliable or responsible for any subsequent events.





CMOS CAMERA MODULES



your BEST camera module partner

KLT Strength

Powerful Factory



www.KaiLapTech.com

www.KaiLapTech.com

Professional Service



www.KaiLapTech.com

www.KaiLapTech.com

Promised Delivery



www.KaiLapTech.com

www.KaiLapTech.com

www.KaiLapTech.com sales@KaiLapTech.com Tel: (852) 6908 1256 Fax: (852) 3017 6778

All rights reserved @ Kai Lap Technologies Group Ltd. Specifications subject to change without notice.